

SFP+ Dual LC Optical Transceivers

Introduction

This design guide provides the information needed to incorporate OptixCom's fiber optics transceiver products in the customer's system. The SFP+ series of the transceiver products are compliant with the SFP+ multi-source agreement. For more detail information, please refer to the URL <http://www.sfplustransceiver.com/pdf/MSA-SFF-8431.pdf> or visit OptixCom web site: <http://www.OptixCom.com> for the official documentation. SFP+ optical transceivers are designed to operate at 6.25 to 10 Gb/s with enhanced electrical interface.

The reference guide covers the following topics:

- A. Pin Assignment & Description
- B. Recommended Interface Circuit
- C. Package Outline
- D. SFP Transceiver Host Board Mechanical Layout
- E. Electrical Connector Mechanical Layout
- F. Connector Insertion, Extraction, and Retention Force
- G. Timing Requirements of Control and Status I/O
- H. Module Definition Interface and Data Field Description



A. Pin Assignment & Description

The SFP transceiver contains a printed circuit board that mates with the SFP electrical connector. The pads are designed for a sequenced mating:

- First mate - ground contacts
- Second mate - power contacts
- Third mate - signal contacts

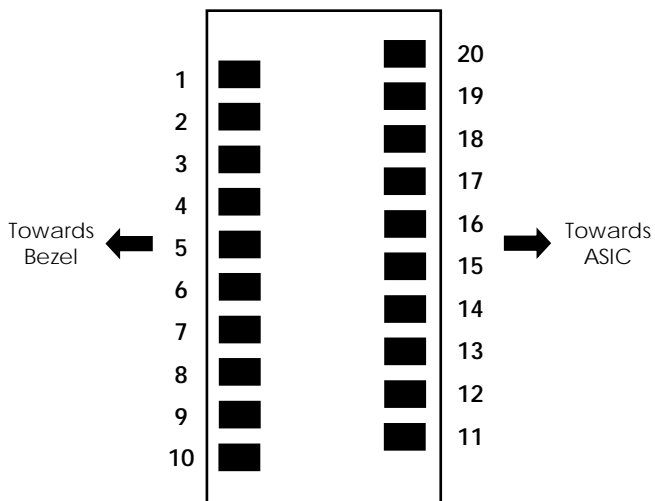

Host Board Connector Pad Layout

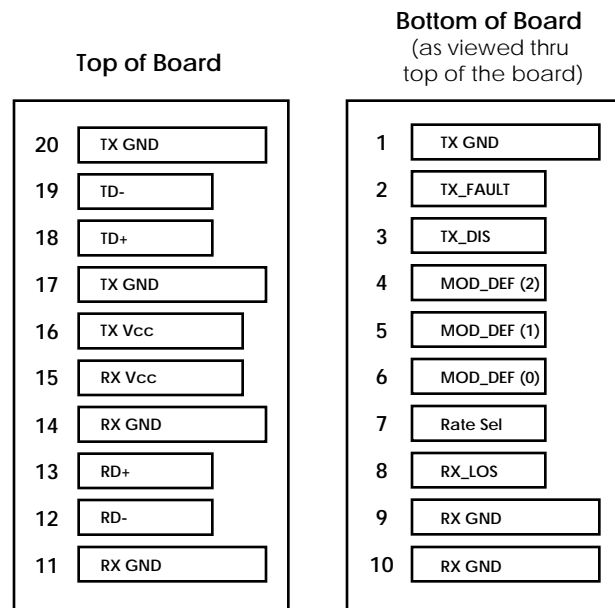

SFP+ Transceiver Pad Layout

PIN	Symbol	Description	PIN	Symbol	Description
1	TX GND	Transmitter Ground	11	RX GND	Receiver Ground
2	TX_FAULT	Transmitter Fault	12	RD-	Receiver Data Output -
3	TX_DIS	Transmitter Disable	13	RD+	Receiver Data output +
4	MOD_DEF (2)	Module Definition (2)	14	RX GND	Receiver Ground
5	MOD_DEF (1)	Module Definition (1)	15	RX Vcc	Receiver Power Supply
6	MOD_DEF (0)	Module Definition (0)	16	TX Vcc	Transmitter Power Supply
7	Rate Sel	Rate Select	17	TX GND	Transmitter Ground
8	RX_LOS	Receiver Loss of Signal	18	TD+	Transmitter Data Input +
9	RX GND	Receiver Ground	19	TD-	Transmitter Data Input -
10	RX GND	Receiver Ground	20	TX GND	Transmitter Ground

RX_LOS: It is an open collector/drain output, which should be pulled up with a 4.7K - 10K resistor. Pull up voltage between 2.0V and TX Vcc. TTL logic HIGH when the receiver optical power is below the worst-case receiver sensitivity, logic LOW otherwise for normal operation. Connect to ground if not needed. In the low state, the output will be pulled to < 0.8V.

TX DIS: It is an input used to shut down the transmitter optical output. It is pulled up within the module with a 4.7 K - 10 K resistor. TTL logic HIGH when the transmitter is turned off. Open collector compatible. Connect to ground if not needed. Its states are:

Low (0 - 0.8V): Transmitter on
 (>0.8, < 2.0V): Undefined
 High (2.0 - 3.5V): Transmitter Disabled
 Open: Transmitter Disabled

TX_FAULT: It is an open collector/drain output, which should be pulled up with a 4.7K - 10K resistor on the host board. Pull up voltage between 2.0V and TX Vcc. TTL logic HIGH when the transmitter is in fault condition and the laser is turned off. Can be reset by TX_DIS. Low indicates normal operation. In the low state, the output will be pulled to < 0.8V. Open collector compatible. Connect to ground if not needed.

Rate Sel.: TTL logic. This is an optional input used to control the receiver bandwidth for compatibility with multiple data rates (most likely Fibre Channel 1x and 2x Rates). If implemented, the input will be internally pulled down with > 30k resistor. The input states are:

Low (0 - 0.8V): Reduced Bandwidth
 (>0.8, < 2.0V): Undefined
 High (2.0 - 3.465V): Full Bandwidth
 Open: Reduced Bandwidth

MOD_DEF (0): Module definition and presence bit 0. TTL logic LOW after power up.

MOD_DEF (1): Module definition and presence bit 1. TTL logic LOW or Serial Clock Signal (SCL) for protocol.

MOD_DEF (2): Module definition and presence bit 2. TTL logic LOW or Serial Data Signal (SDA) for protocol.

MOD_DEF (0), (1), (2) are the module definition pins. They should be pulled up with a 4.7K - 10K resistor on the host board. The pull-up voltage shall be TX Vcc or RX Vcc.

Mod-Def (0) is grounded by the module to indicate that the module is present. Mod-Def (1) is the clock line of two wire serial interface for serial ID. Mod-Def (2) is the data line of two wire serial interface for serial ID.

TD+, TD-: AC coupling, PECL differential transmitter inputs with 100 Ω differential lines inside the module. The AC coupling is done inside the module and is thus not required on the host board. The inputs will accept differential swings of 500 - 2400 mV (250 - 1200 mV single-ended), though it is recommended that values between 500 and 1200 mV differential (250 - 600 mV single-ended) be used for best EMI performance.

RD+, RD-: AC coupling, PECL differential receiver outputs. 100 Ω differential lines terminated at the user SERDES. The AC coupling is done inside the module and is thus not required on the host board. The voltage swing on these lines will be between 370 and 2000 mV differential (185 - 1000 mV single ended) when properly terminated.

B. Recommended Interface Circuit

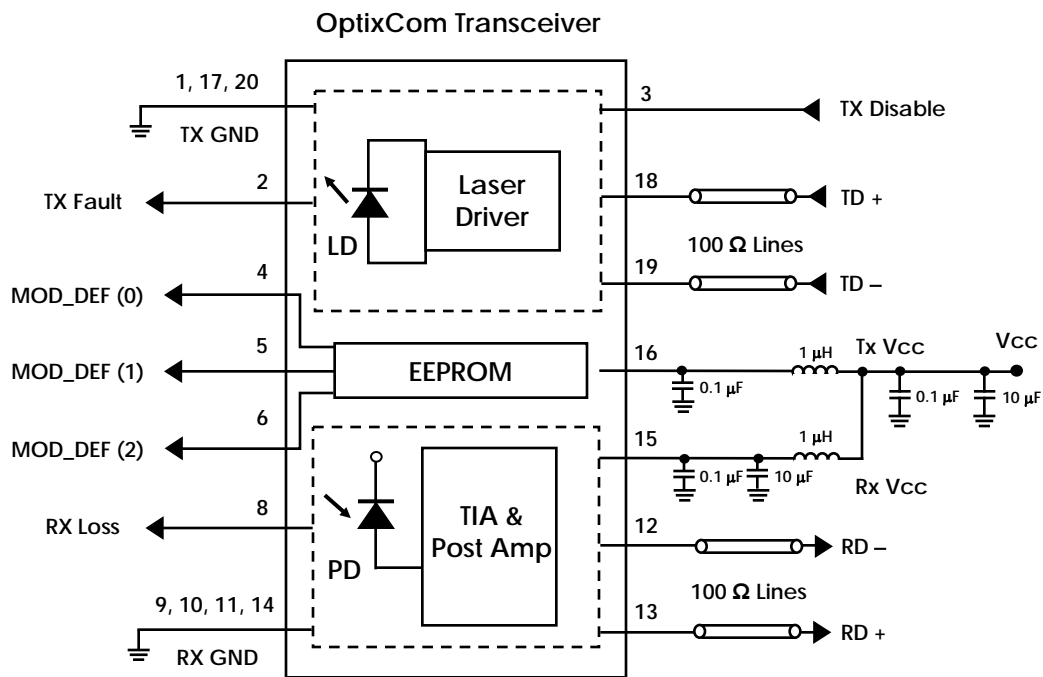

All the TTL interface logic pins are open collector compatible. A pull up resistor R_p is used in the following scheme. The value of R_p is between 4.7K Ω to 10K Ω .



C. Package Outline

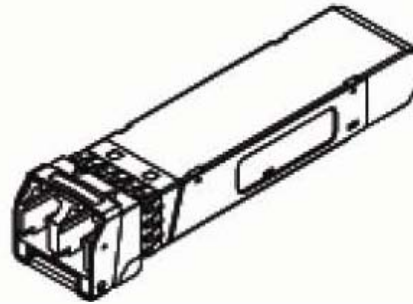

Top View

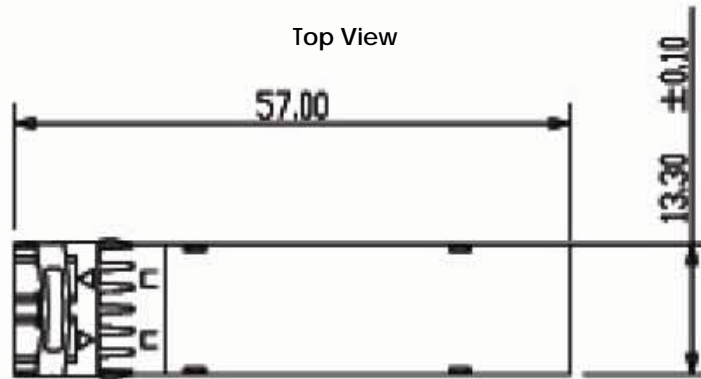

Side View

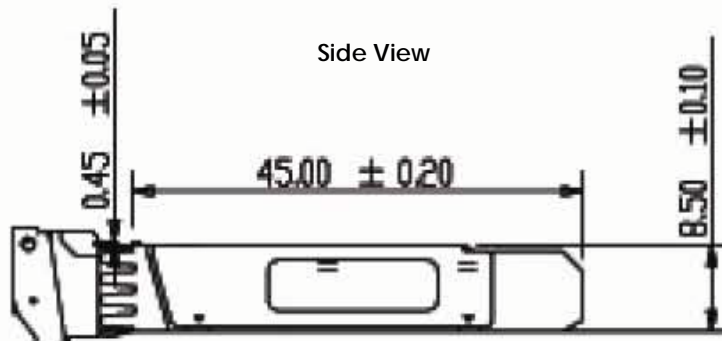

Front View

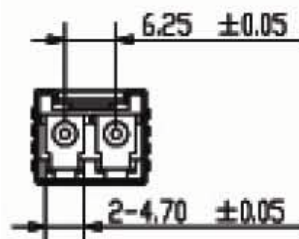

Unit: mm, typical tolerance for these dimensions is ± 0.2 mm

Connector Dimensions

Designator	Dimension (mm)	Tolerance (mm)	Comments
A	9.4	± 0.08	Connector card slot width
B	1.4	± 0.05	Guide pin diameter
C	11.2	Maximum	Connector width
D	9.2	Maximum	Connector length
E	3.5	Reference	Distance from centerline of connector to outer contact
F	3.9	Reference	Distance from centerline of connector to outer contact
G	1.35	Maximum	Connector card slot height
H	2.6	Minimum	Height from bottom of connector to bottom of card slot
J	9.6	TP	Distance between guide pins
K	0.9	Reference	Diamond guide pin width
L	1.4	± 0.05	Diamond guide pin length
M	5.4	Maximum	Connector height
N	0.8	Reference	Length of solder leads past housing, front & rear
P	6.0	Minimum	Depth of card slot from front face of housing
Q	3.0	Maximum	Depth of contact point from front face of connector
R	0.7	± 0.1	Size of chamfer on top face of connector
S	0.3	Reference	Distance boss extends past front face of connector
T	1.0	Minimum	Size of chamfer at entry of card slot, all around
U	4.5	Reference	Length from centerline of guide posts to end of solder lead

F. Connector Insertion, Extraction, and Retention Force

The requirement for the various functional forces and the durability cycles are specified in the following Table.

Insertion, Extraction, and Retention Force

Measurement	Minimum	Maximum	Units	Comments
SFP transceiver insertion	0	40	Newtons	
SFP transceiver extraction	0	11.5	Newtons	
SFP transceiver retention	90	170	Newtons	No damage to transceiver below 90N
Cage retention (Latch strength)	180	N/A	Newtons	No damage to latch below 180N
Cage kickout spring force	11.5	22	Newtons	
Insertion / removal cycles, connector/cage	100	N/A	cycles	
Insertion / removal cycles, SFP transceiver	50	N/A	cycles	

G. Timing Requirements of Control and Status I/O

The timing requirements of the control and status lines are drawn largely from the GBIC standard at the time of writing. They are summarized in the Table below:

Timing Requirements of Control and Status I/O

Parameter	Symbol	Min	Max	Unit	Condition
TX Disable Assert Time	t_off		10	μs	Time from rising edge of TX Disable to when the optical output falls below 10% of nominal
TX Disable Negate Time	t_on		1	ms	Time from falling edge of TX Disable to when the modulated optical output rises above 90% of nominal
Time to initialize, including reset of TX_Fault	t_init		300	ms	From power on or negation of TX Fault using TX Disable
TX Fault Assert Time	t_fault		100	μs	Time from fault to TX fault on.
TX Disable to reset	t_reset	10		μs	Time TX Disable must be held high to reset TX_fault
LOS Assert Time	t_loss_on		100	μs	Time from LOS state to RX LOS assert
LOS Deassert Time	t_loss_off		100	μs	Time from non-LOS state to RX LOS deassert
Rate-Select Change Time	t_ratesel		10	μs	Time from rising or falling edge of Rate Select input until receiver bandwidth is in conformance with appropriate specification.
Serial ID Clock Rate	f_serial_clock		100	kHz	

SFP transceiver power on initialization procedure, TX_DISABLE negated.

During power on of the SFP transceiver, TX_FAULT, if implemented, may be asserted (High) as soon as power supply voltages are within specification. For transceiver initialization with TX_DISABLE negated, TX_FAULT shall be negated when the transmitter safety circuitry, if implemented, has detected that the transmitter is operating in its normal state. If a transmitter fault has not occurred, TX_FAULT shall be negated within a period t_init from the time that TX Vcc exceeds the specified minimum operating voltage.

If TX_FAULT remains asserted beyond the period t_init, the host may assume that a transmission fault has been detected by the transceiver. If no transmitter safety circuitry is implemented, the TX_FAULT signal may be tied to its negated state.

The power-on initialization timing for a transceiver with TX_DISABLE negated is shown in the following figure.

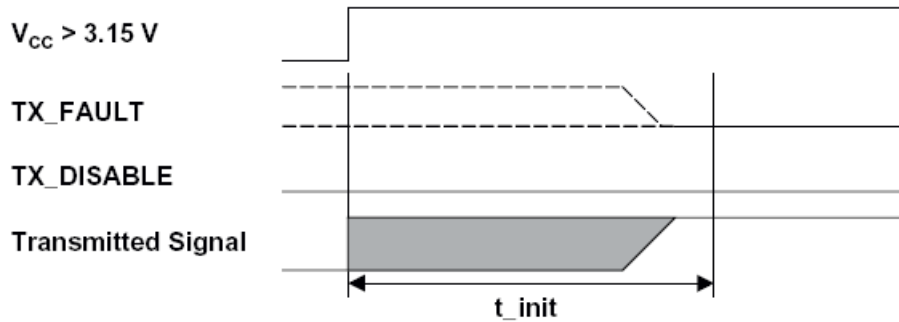

Power on initialization of SFP transceiver, TX_DISABLE negated

SFP transceiver power on initialization procedure, TX_DISABLE asserted.

For SFP transceiver power on initialization with TX_DISABLE asserted, the state of TX_FAULT is not defined while TX_DISABLE is asserted. After TX_DISABLE is negated, TX_FAULT may be asserted while safety circuit initialization is performed. TX_FAULT shall be negated when the transmitter safety circuitry, if implemented, has detected that the transmitter is operating in its normal state. If a transmitter fault has not occurred, TX_FAULT shall be negated within a period t_{init} from the time that TX_DISABLE is negated. If TX_FAULT remains asserted beyond the period t_{init} , the host may assume that a transmission fault has been detected by the transceiver.

If no transmitter safety circuitry is implemented, the TX_FAULT signal may be tied to its negated state. The power-on initialization timing for a SFP transceiver with TX_DISABLE asserted is shown in the following figure.

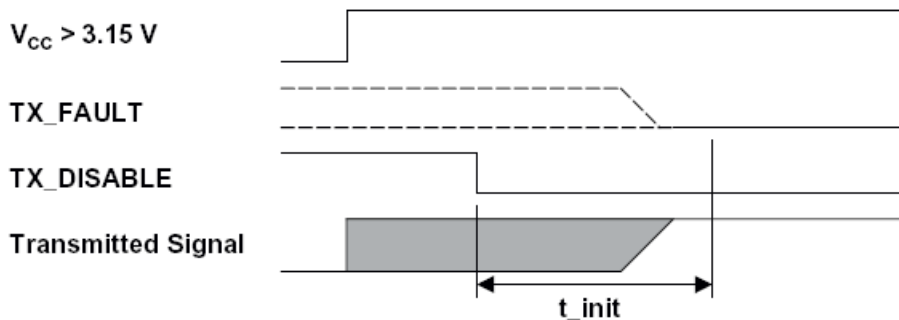

Power on initialization of SFP, TX_DISABLE asserted Initialization during hot plugging of SFP TRANSCEIVER

When a transceiver is not installed, TX_FAULT is held to the asserted state by the pull up circuits on the host. As the SFP transceiver is installed, contact is made with the ground, voltage, and signal contacts in the specified order. After the SFP has determined that TX Vcc has reached the specified value, the power on initialization takes place as described in the above sections. An example of initialization during hot plugging is provided in the following figure.

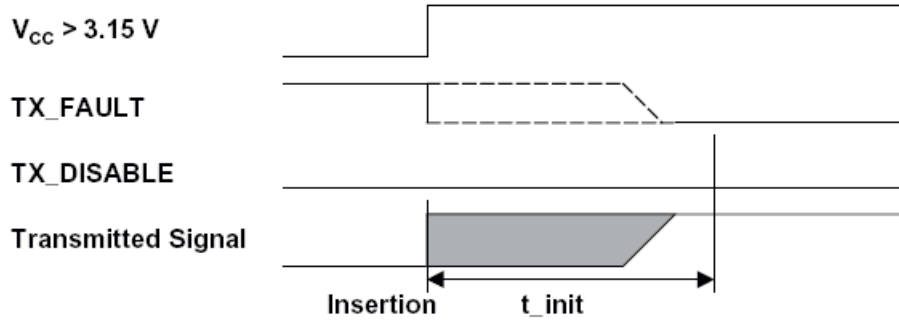

Example of initialization during hot plugging, TX_DISABLE negated.

SFP transmitter management

The timing requirements for the management of optical outputs from the SFP transceiver using the TX_DISABLE signal are shown in the figure below. Note that the t on time refers to the maximum delay until the modulated optical signal reaches 90% of the final value, not just the average optical power.

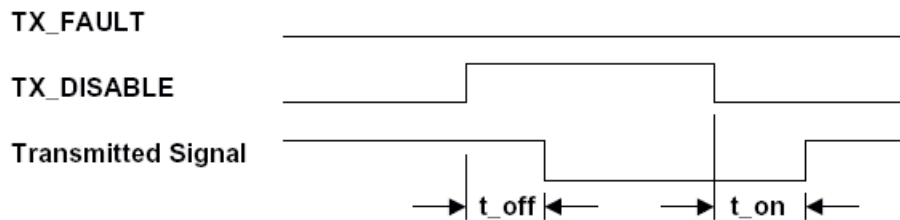

SFP TX_DISABLE timing during normal operation

SFP transceiver fault detection and presentation

TX_FAULT shall be implemented by those module definitions of SFP transceiver supporting safety circuitry. If TX_FAULT is not implemented, the signal shall be held to the low state by the SFP transceiver.

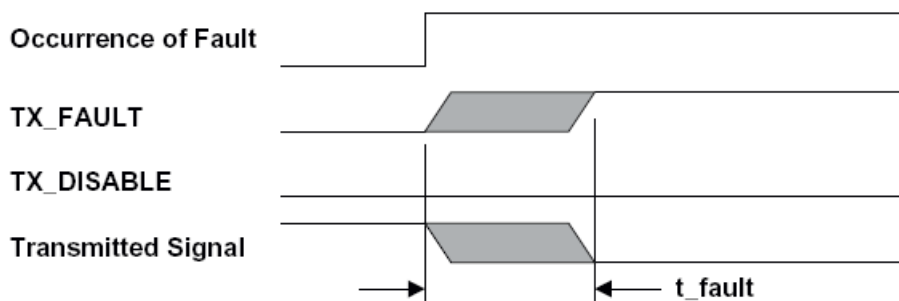

Detection of transmitter safety fault condition

SFP transceiver fault recovery

The detection of a safety-related transmitter fault condition presented by TX_FAULT shall be latched. The following protocol may be used to reset the latch in case the transmitter fault condition is transient. To reset the fault condition and associated detection circuitry, TX_DISABLE shall be asserted for a minimum of t_{reset} . TX_DISABLE shall then be negated. In less than the maximum value of t_{init} the optical transmitter will correctly reinitialize the laser circuits, negate TX_FAULT, and begin normal operation if the fault condition is no longer present. If a fault condition is detected during the re-initialization, TX_FAULT shall again be asserted, the fault condition again latched, and the optical transmitter circuitry will again be disabled until the next time a reset protocol is attempted. The manufacturer of the SFP shall ensure that the optical power emitted from an open connector or fiber is compliant with IEC825-1 and CDRH during all reset attempts, during normal operation or upon the occurrence of reasonable single fault conditions. The SFP transceiver may require internal protective circuitry to prevent the frequent assertion of the TX_DISABLE signal from generating frequent pulses of energy that violate the safety requirements. The timing for successful recovery from a transient safety fault condition is shown in the following figure.

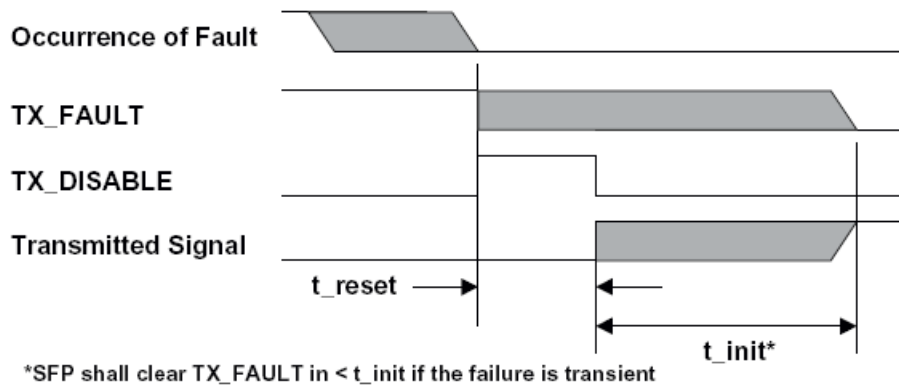

Successful recovery from transient safety fault condition

An example of an unsuccessful recovery, where the fault condition was not transient, is shown in the following figure.

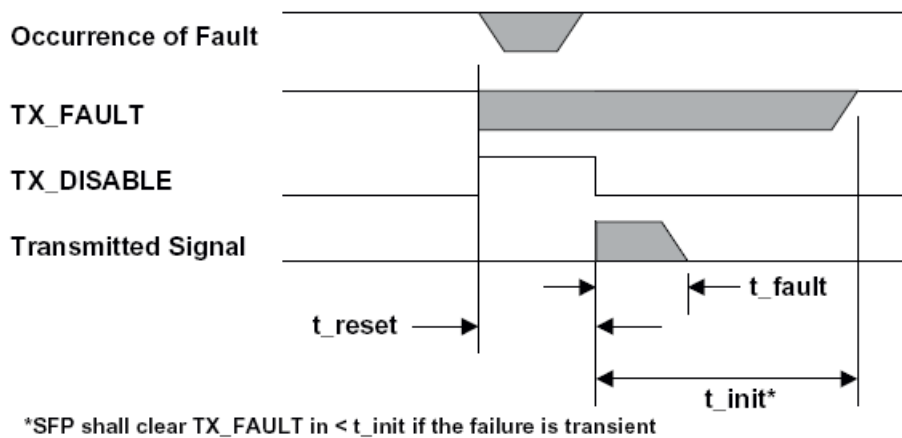

Unsuccessful recovery from safety fault condition

SFP transceiver loss of signal indication

The LOS signal is intended as a preliminary indication to the system in which the SFP transceiver is installed that the link signals are likely to be outside the required values for proper operation. Such indications typically point to non-installed cables, broken cables, or a disabled, failing or powered off transmitter at the far end of the cable. Additional indications are provided by the system in which the SFP transceiver is installed to verify that the information being transmitted is valid, correctly encoded, and in the correct format. Such additional indications are outside the scope of the SFP TRANSCEIVER MSA. The timing of the LOS function is specified in the following figure.

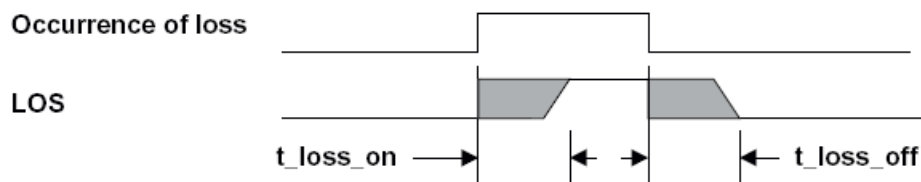

Timing of LOS detection

H. Module Definition Interface and Data Field Description

The definition of the MOD-DEF function is drawn largely from the GBIC standard with some small, but backwards compatible, changes to the fields or allowed values to reflect the latest standards and expectations for these transceivers. In some cases, this backward compatibility approach results in the possibility of illegal combinations (such as defining an SFP module with SC optical connectors). Some locations previously reserved in the GBIC serial identification have now been defined.

It should be noted that only the serial module definition and the basic Mod-Def 0 indication of module present are implemented. The use of MOD DEF lines as static codes for module definition as done with GBIC are not implemented.

Overview

The SFP serial ID provides access to sophisticated identification information that describes the transceiver's capabilities, standard interfaces, manufacturer, and other information. The serial interface uses the 2-wire serial CMOS E2PROM protocol defined for the ATMEL AT24C01A/02/04 family of components.

When the serial protocol is activated, the host generates the serial clock signal (SCL, Mod Def 1). The positive edge clocks data into those segments of the E2PROM that are not write-protected within the SFP transceiver. The negative edge clocks data from the SFP transceiver.

The serial data signal (SDA, Mod Def 2) is bi-directional for serial data transfer. The host uses SDA in conjunction with SCL to mark the start and end of serial protocol activation. The memories are organized as a series of 8-bit data words that can be addressed individually or sequentially.

This section defines the information structures that are obtained from the SFP transceiver via the serial ID.

A SFP transceiver shall meet the electrical and optical requirements, including amplitude, eye diagram, jitter, and other parameters, specified for the standards with which the transceiver claims compliance.

Serial information definition

The 2-wire serial CMOS E2PROM provides sequential or random access to 8 bit parameters, addressed from 0000h to the maximum address of the memory. The address select pins for the serial CMOS E2PROM shall be set to zero (fixed at the VIL low level). The fields specified by this section shall not be written by the host in which it is installed. The SFP transceiver may enforce this by using the write protect features of the CMOS E2PROM.

The word address is transmitted with the high order bit transmitted first. The protocol for the 2-wire serial interface sequentially transmits one or more 8-bit bytes, with the data byte addressed by the lowest word address transmitted first. In each data byte, the high order bit (bit 7 in the accompanying tables) is transmitted first.

Numeric fields are expressed in binary, with the high order byte being transferred first and the high order bit of each byte being transferred first. Numeric fields are padded on the left with binary zero values.

Character strings are ordered with the first character to be displayed located in the lowest word address of the string. Each character shall be coded as a US-ASCII character as defined by ISO 8859-1, with the high order bit transmitted first. All character strings will be padded on the right with ASCII spaces (20h) to fill empty bytes.

All bits of reserved fields shall be set to zero until future definitions require their use.

A minimum of 96 bytes shall be readable by the serial identification process.

The maximum clock rate of the serial interface shall be 100 KHz. The following tables define the contents of the serial CMOS E2PROM. The first table is a summary of all the data fields in the serial ID chip. The remaining tables contain detailed descriptions of the individual data fields.

Serial ID: Data Fields

Data Address	Field Size (Bytes)	Name of field	Description of field
BASE ID FIELDS			
0	1	Identifier	Type of serial transceiver (see Table 3.2)
1	1	Ext. Identifier	Extended identifier of type of serial transceiver
2	1	Connector	Code for connector type (see Table 3.3)
3-10	8	Transceiver	Code for electronic compatibility or optical compatibility (see Table 3.4)
11	1	Encoding	Code for serial encoding algorithm (see Table 3.5)
12	1	BR, Nominal	Nominal bit rate, units of 100 Mbits/sec.
13	1	Reserved	
14	1	Length(9m) - km	Link length supported for 9/125 mm fiber, units of km
15	1	Length (9m)	Link length supported for 9/125 mm fiber, units of 100 m
16	1	Length (50m)	Link length supported for 50/125 mm fiber, units of 10 m
17	1	Length (62.5m)	Link length supported for 62.5/125 mm fiber, units of 10 m
18	1	Length (Copper)	Link length supported for copper, units of meters
19	1	Reserved	
20-35	16	Vendor name	SFP transceiver vendor name (ASCII)
36	1	Reserved	
37-39	3	Vendor OUI	SFP transceiver vendor IEEE company ID
40-55	16	Vendor PN	Part number provided by SFP transceiver vendor (ASCII)
56-59	4	Vendor rev	Revision level for part number provided by vendor (ASCII)
60-62	3	Reserved	
63	1	CC_BASE	Check code for Base ID Fields (addresses 0 to 62)
EXTENDED ID FIELDS			
64-65	2	Options	Indicates which optional SFP signals are implemented (see Table 3.6)
66	1	BR, max	Upper bit rate margin, units of %
67	1	BR, min	Lower bit rate margin, units of %
68-83	16	Vendor SN	Serial number provided by vendor (ASCII)
84-91	8	Date code	Vendor's manufacturing date code (see Table 3.7)
92-94	3	Reserved	
95	1	CC_EXT	Check code for the Extended ID Fields (addresses 64 to 94)
VENDOR SPECIFIC ID FIELDS			
96-127	32	Read-only	Vendor specific data, read only
128-511	384	Reserved	
512-n			Vendor specific

Identifier

The identifier value specifies the physical device described by the serial information. This value shall be included in the serial data. The defined identifier values are shown in the following Table.

Identifier Values

Value	Description of Physical Device
00h	Unknown or unspecified
01h	GBIC
02h	Module/connector soldered to motherboard
03h	SFP transceiver
04-7Fh	Reserved
80-FFh	Vendor specific

Extended Identifier

The field should be set to 04h for all SFP modules indicating serial ID module definition.

Connector

The Connector value indicates the external connector provided on the interface. This value shall be included in the serial data. The defined connector values are shown in Table below. Note that 01h - 05h are not SFP compatible, and are included for compatibility with GBIC standards.

Connector Values

Value	Description of Connector
00h	Unknown or unspecified
01h	SC
02h	Fibre Channel Style 1 copper connector
03h	Fibre Channel Style 2 copper connector
04h	BNC/TNC
05h	Fibre Channel coaxial headers
06h	FiberJack
07h	LC
08h	MT-RJ
09h	MU
0Ah	SG
0Bh	Optical pigtail
0C-1Fh	Reserved
20h	HSSDC II
21h	Copper Pigtail
22h-7Fh	Reserved
80-FFh	Vendor specific

Transceiver

The following bit significant indicators define the electronic or optical interfaces that are supported by the SFP transceiver. At least one bit shall be set in this field. For Fibre Channel SFPs, the Fibre Channel speed, transmission media, transmitter technology, and distance capability shall all be indicated.

Transceiver codes

Data Addr	Bit ¹	Description of transceiver	Data Addr	Bit ¹	Description of transceiver
Reserved Standard Compliance Codes			Fibre Channel link length		
3	7-0	Reserved	7	7	very long distance (V)
4	7-4	Reserved	7	6	short distance (S)
SONET Compliance Codes			7	5	intermediate distance (I)
4	3	Reserved	7	4	long distance (L)
4	2	OC 48, long reach	Fibre Channel transmitter technology		
4	1	OC 48, intermediate reach	7	3-2	Reserved
4	0	OC 48 short reach	7	1	Longwave laser (LC)
5	7	Reserved	7	0	Electrical inter-enclosure (EL)
5	6	OC 12, single mode long reach	8	7	Electrical intra-enclosure (EL)
5	5	OC 12, single mode inter. reach	8	6	Shortwave laser w/o OFC (SN)
5	4	OC 12 multi-mode short reach	8	5	Shortwave laser w/ OFC (SL)
5	3	Reserved	8	4	Longwave laser (LL)
5	2	OC 3, single mode long reach	8	0-3	Reserved
5	1	OC 3, single mode inter. reach	Fibre Channel transmission media		
5	0	OC 3, multi-mode short reach	9	7	Twin Axial Pair (TW)
			9	6	Shielded Twisted Pair (TP)
			9	5	Miniature Coax (MI)
Gigabit Ethernet Compliance Codes			9	4	Video Coax (TV)
6	7-4	Reserved	9	3	Multi-mode, 62.5m (M6)
6	3	1000BASE-T	9	2	Multi-mode, 50 m (M5)
6	2	1000BASE-CX	9	1	Reserved
6	1	1000BASE-LX	9	0	Single Mode (SM)
6	0	1000BASE-SX	Fibre Channel speed		
			10	7-5	Reserved
			10	4	400 MBytes/Sec
			10	3	Reserved
			10	2	200 MBytes./Sec
			10	1	Reserved
			10	0	100 MBytes/Sec

¹ Bit 7 is the high order bit and is transmitted first in each cycle

Encoding

The encoding value indicates the serial encoding mechanism that is the nominal design target of the particular SFP transceiver. The value shall be contained in the serial data. The defined encoding values are shown in the Table below.

Encoding Codes

code	Description of encoding mechanism
00h	Unspecified
01h	8B10B
02h	4B5B
03h	NRZ
04h	Manchester
05h -FFh	Reserved

BR, nominal

The nominal bit rate (BR, nominal) is specified in units of 100 Megabits per second, rounded off to the nearest 100 Megabits per second. The bit rate includes those bits necessary to encode and delimit the signal as well as those bits carrying data information. A value of 0 indicates that the bit rate is not specified and must be determined from the transceiver technology. The actual information transfer rate will depend on the encoding of the data, as defined by the encoding value.

Length (9 μ)-km

Addition to EEPROM data from original GBIC definition. This value specifies the link length that is supported by the SFP transceiver while operating in compliance with the applicable standards using single mode fiber. The value is in units of kilometers. A value of 255 means that the transceiver supports a link length greater than 254 km. A value of zero means that the transceiver does not support single mode fiber or that the length information must be determined from the transceiver technology.

Length (9 μ)

This value specifies the link length that is supported by the SFP transceiver while operating in compliance with the applicable standards using single mode fiber. The value is in units of 100 meters. A value of 255 means that the transceiver supports a link length greater than 25.4 km. A value of zero means that the SFP transceiver does not support single mode fiber or that the length information must be determined from the transceiver technology.

Length (50 μ)

This value specifies the link length that is supported by the SFP transceiver while operating in compliance with the applicable standards using 50 micron multi-mode fiber. The value is in units of 10 meters. A value of 255 means that the SFP transceiver supports a link length greater than 2.54 km. A value of zero means that the transceiver does not support 50 micron multi-mode fiber or that the length information must be determined from the transceiver technology.

Length (62.5 μ)

This value specifies the link length that is supported by the SFP transceiver while operating in compliance with the applicable standards using 62.5 micron multi-mode fiber. The value is in units of 10 meters. A value of 255 means that the SFP transceiver supports a link length greater than 2.54 km. A value of zero means that the SFP transceiver does not support 62.5 micron multi-mode fiber or that the length information must be determined from the transceiver technology. It is common for the SFP transceiver to support both 50 micron and 62.5 micron fiber.

Length (Copper)

This value specifies the minimum link length that is supported by the SFP transceiver while operating in compliance with the applicable standards using copper cable. The value is in units of 1 meter. A value of 255 means that the SFP transceiver supports a link length greater than 254 meters. A value of zero means that the SFP transceiver does not support copper cables or that the length information must be determined from the transceiver technology. Further information about the cable design, equalization, and connectors is usually required to guarantee meeting a particular length requirement.

Vendor name

The vendor name is a 16 character field that contains ASCII characters, left-aligned and padded on the right with ASCII spaces (20h). The vendor name shall be the full name of the corporation, a commonly accepted abbreviation of the name of the corporation, the SCSI company code for the corporation, or the stock exchange code for the corporation. At least one of the vendor name or the vendor OUI fields shall contain valid serial data.

Vendor OUI

The vendor organizationally unique identifier field (vendor OUI) is a 3-byte field that contains the IEEE Company Identifier for the vendor. A value of all zero in the 3-byte field indicates that the Vendor OUI is unspecified.

Vendor PN

The vendor part number (vendor PN) is a 16-byte field that contains ASCII characters, left-aligned and padded on the right with ASCII spaces (20h), defining the vendor part number or product name. A value of all zero in the 16-byte field indicates that the vendor PN is unspecified.

Vendor Rev

The vendor revision number (vendor rev) is a 4-byte field that contains ASCII characters, left-aligned and padded on the right with ASCII spaces (20h), defining the vendor's product revision number. A value of all zero in the 4-byte field indicates that the vendor Rev is unspecified.

CC_BASE

The check code is a one byte code that can be used to verify that the first 64 bytes of serial information in the SFP transceiver is valid. The check code shall be the low order 8 bits of the sum of the contents of all the bytes from byte 0 to byte 62, inclusive.

Options

The bits in the option field shall specify the options implemented in the SFP transceiver as described in the following Table.

Option Values

data address	bit	Description of option
64	7-0	Reserved
65	7-6	Reserved
65	5	RATE_SELECT is implemented If bit is set then active control of the rate select pin is required to change rates. If bit is not set, no control of pin is required. In all cases, compliance with multiple rate standards should be determined by Transceiver Codes in Bytes 4, 5, 6 and 10. (See Table 3.4)
65	4	TX_DISABLE is implemented and disables the serial output.
65	3	TX_FAULT signal implemented. (Reset defined in section III)
65	2	Loss of Signal implemented, signal inverted from definition in Table 1 NOTE: This is not standard SFP transceiver behavior and should be avoided, since non-interoperable behavior results.
65	1	Loss of Signal implemented, signal as defined in Table 1
65	0	Reserved

BR, max

The upper bit rate limit at which the SFP transceiver will still meet its specifications (BR, max) is specified in units of 1% above the nominal bit rate. A value of zero indicates that this field is not specified.

BR, min

The lower bit rate limit at which the SFP transceiver will still meet its specifications (BR, min) is specified in units of 1% below the nominal bit rate. A value of zero indicates that this field is not specified.

Vendor SN

The vendor serial number (vendor SN) is a 16 character field that contains ASCII characters, left-aligned and padded on the right with ASCII spaces (20h), defining the vendor's serial number for the SFP transceiver. A value of all zero in the 16-byte field indicates that the vendor SN is unspecified.

Date Code

The date code is an 8-byte field that contains the vendor's date code in ASCII characters. The date code is mandatory. The date code shall be in the format specified by Table in the following.

Date Code

Data Address	Description of field
84-85	ASCII code, two low order digits of year. (00 = 2000).
86-87	ASCII code, digits of month (01 = Jan through 12 = Dec)
88-89	ASCII code, day of month (01 - 31)
90-91	ASCII code, vendor specific lot code, may be blank

CC_EXT

The check code is a one byte code that can be used to verify that the first 32 bytes of extended serial information in the SFP transceiver is valid. The check code shall be the low order 8 bits of the sum of the contents of all the bytes from byte 64 to byte 94, inclusive.

Read-only

This area may contain vendor specific information which can be read from the SFP transceiver. The data is read only.